



Chazelles



SOLO





Shellstones shown on fireplaces may be replaced by another shellstone, and marble by another type of marble. Rock, wood and other natural materials may not have the same colour, grain or surface appearance as the samples shown.

Page
Página
Seite
Pagina
Страница

Ref.	
CS10	6
CS11	6
CS12	7
CS13	8
CS14	9
CS15	8
CS16	3
CS17	3
CS18	3
CS19	5
CS20	5
CS21	4
CS22	4
CS23	9
CS24	10
CS25	10
CS26	11
CS27	11
CS28	13
CS29	12
CS30	14
CS31	14
CS32	15
CS33	15
CS34	15
CS35	12
CS36	12
CS37	13
CS38	13
G70 - P70	
D70 - D70+G	
D70D - D70G	
V70 - V80	
	16-17

Les pierres coquillières présentées sur les cheminées peuvent être remplacées par une autre pierre coquillière, ainsi que pour les marbres entre eux. Les roches, le bois et autres matériaux naturels ne peuvent pas avoir l'identité de couleur, de veinage et d'aspect de surface conformes aux échantillons présentés.

Las piedras conchíferas presentadas en las chimeneas pueden sustituirse por otras piedras conchíferas, al igual que los mármoles por otros mármoles. Puede que las rocas, la madera y otros materiales naturales no tengan el color, el vetado y el aspecto de superficie de las muestras presentadas.

Die auf dem Kamin dargestellten Muschelkalksteine können durch einen anderen Muschelkalkstein ersetzt werden, dass gilt ebenso für den Marmor. Der Naturstein, das Holz und andere Naturmaterialien können von den dargestellten Mustern in der Farbe, Maserung und der Oberflächenstruktur abweichen.

Pietrele de mare prezentate pe șeminee pot fi înlocuite cu altă piatră de mare iar marmură cu un alt model de marmură. Pietrele, lemnul și alte materiale naturale nu pot avea culoarea, modelul și aspectul suprafeței identice cu eșantioanele prezentate.

Ракушечник, из которого изображен камин, может быть заменен на другой ракушечник, а мрамор другим типом мрамора. Камень, дерево и другие натуральные материалы могут отличаться по цвету, текстуре и внешнему виду от представленных образцов.



With an open fireplace, it is essential to protect the hearth area and back wall from thermal shocks with cast iron firebacks.

Dans le cas du foyer ouvert, Il est impératif de prévoir une protection de la foyère et du fond de foyer contre les chocs thermiques par des plaques en fonte.

En el caso del hogar abierto, la base y el fondo del hogar deben protegerse contra los choques térmicos con placas de fundición.

Bei einer offenen Feuerstelle ist es unbedingt nötig, einen Feuerschutz und einen Schutz für die Rückwand der Feuerstelle mit Hilfe einer Gusseisenplatte vorzusehen, um einen Thermoschock zu verhindern.

În cazul vetrei deschise, este imperativ să se prevadă o protecție a vetrei și a fundului vetrei împotriva șocurilor termice cu plăci din fontă.

В камине с открытой топкой необходимо защищать стенки топочной камеры от термического шока чугунной пластиной.

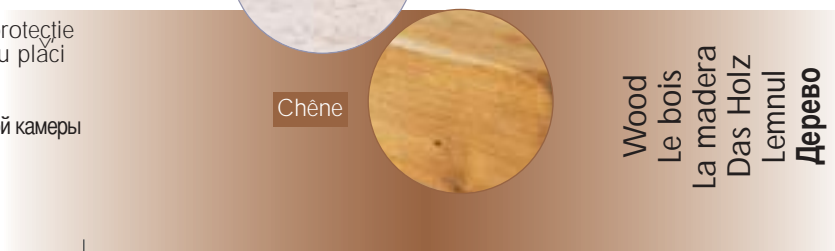
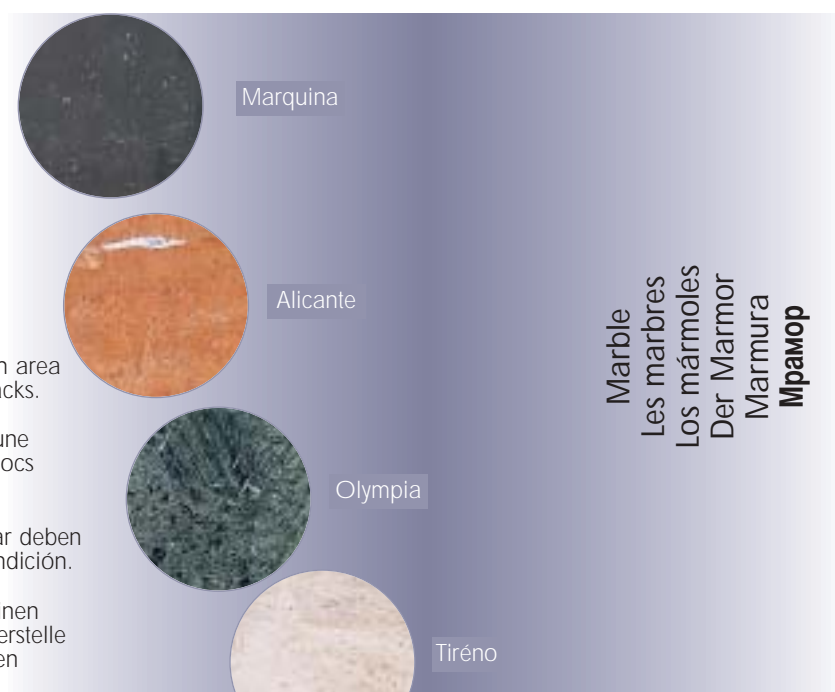
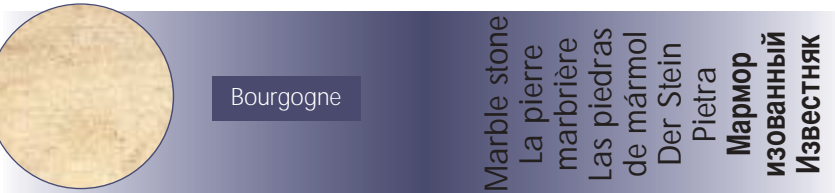



CS16

Brétignac
Cevennes

141 x 69 x 114

	CS16067PC	CS16067MP
	CS16700PC	CS16700MP
	CS16700PC	CS16700MP
	CS16700PC	CS16700MP

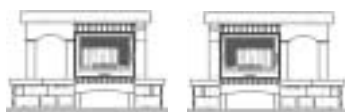

181 x 69 x 115

	CS18067PC	CS18067MP
	CS18700PC	CS18700MP
	CS18700PC	CS18700MP
	CS18700PC	CS18700MP



CS18

Mauzens
Cevennes
Chêne



CS17

Brétignac
Cevennes
Chêne

117/117 x 50 x 115

	CS17067PC	CS17067MP
	CS17700PC	CS17700MP
	CS17700PC	CS17700MP
	CS17700PC	CS17700MP



CS22
Saintonge Opus
Cevennes
Chêne

125/125 x 45 x 116

	CS22067PC	CS22067MP
	CS22700PC	CS22700MP
	CS22700PC	CS22700MP
	CS22700PC	CS22700MP
	CS22700PC	CS22700MP



CS21
Bourgogne opus
Bourgogne
Cevennes
Chêne

138 x 68 x 115

	CS21067PC	CS21067MP
	CS21700PC	CS21700MP
	CS21700PC	CS21700MP
	CS21700PC	CS21700MP





CS19

Bourgogne opus
Mauzens
Cevennes
Chêne



141 x 69 x 115

	CS19067PC	CS19067MP
	CS19700PC	CS19700MP
	CS19700PC	CS19700MP
	CS19700PC	CS19700MP



CS20

Bourgogne opus
Gard
Cevennes
Chêne



141 x 69 x 114

	CS20067PC	CS20067MP
	CS20700PC	CS20700MP
	CS20700PC	CS20700MP
	CS20700PC	CS20700MP





CS10
Gard
Cevennes
Chêne



131 x 69 x 115

	CS10067PC	CS10067MP
	CS10700PC	CS10700MP
	CS10700PC	CS10700MP
CS100BUCHER		



CS11
Mauzens
Cevennes



93/93 x 130 x 114

	CS11067PC	CS11067MP
	CS11700PC	CS11700MP
	CS11700PC	CS11700MP
CS110BUCHER		





CS12
Brétignac
Cevennes

161 x 69 x 114

	CS12067PC	CS12067MP
	CS12700PC	CS12700MP
	CS12700PC	CS12700MP
CS120BUCHER		

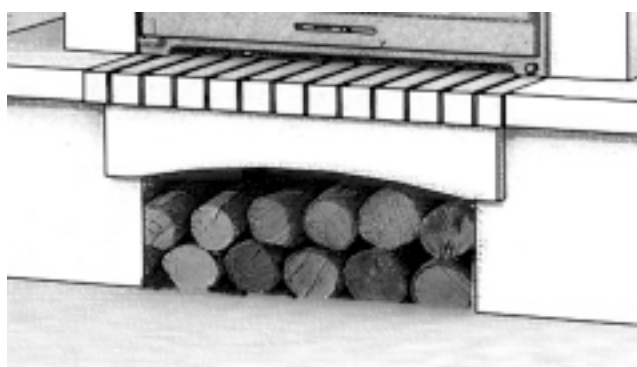
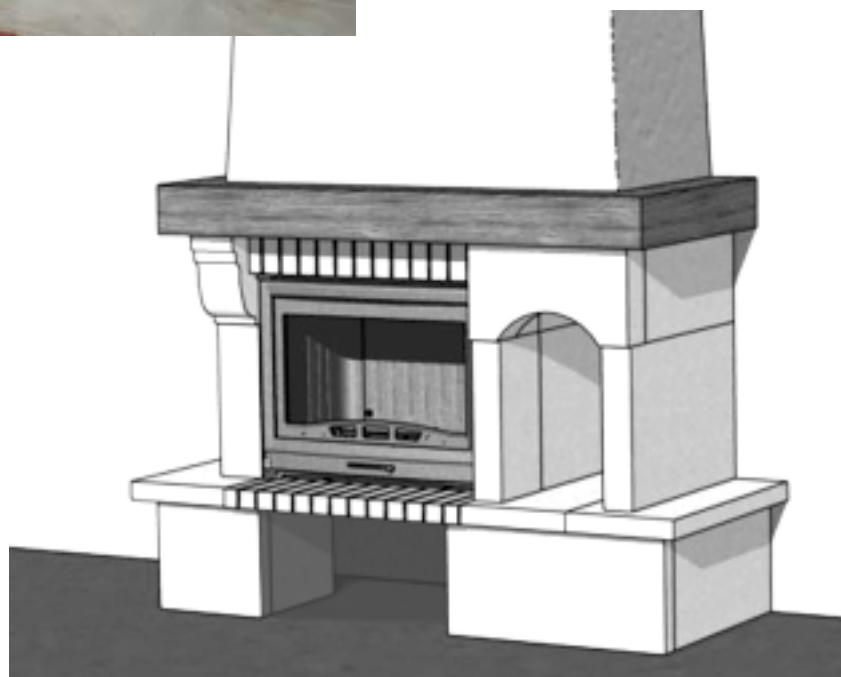

CS10	CS100BUCHER
CS11	CS110BUCHER
CS12	CS120BUCHER

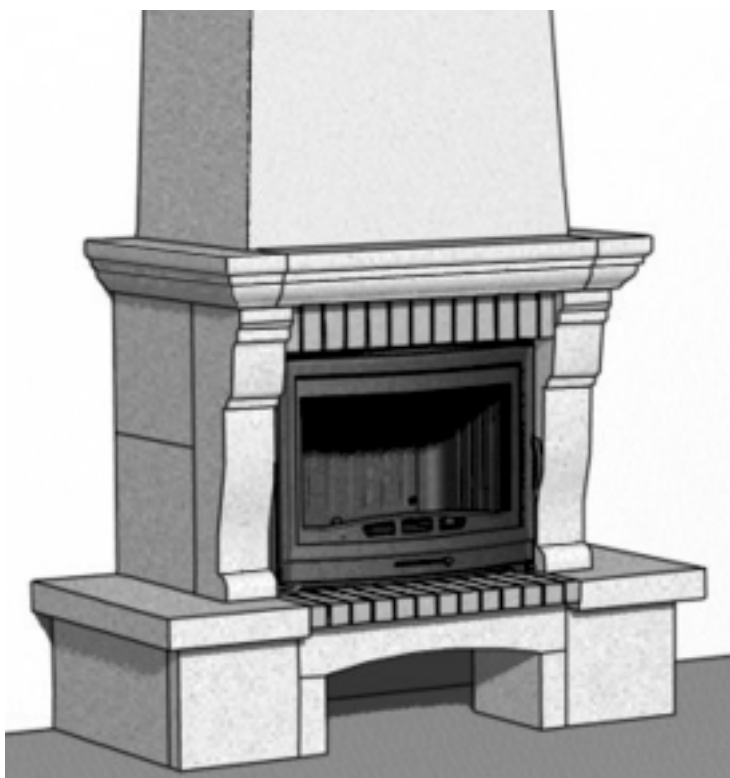

CS13

141 x 69 x 114

	CS13067PC	CS13067MP
	CS13700PC	CS13700MP
	CS13700PC	CS13700MP
	CS13700PC	CS13700MP



CS15
Brétignac
Tiréno

141 x 69 x 114

	CS15067MP
	CS15700MP
	CS15700MP
	CS15700MP





CS23
Mauzens
Alicante



114/114 x 37 x 115

	CS23067MP
	CS23700MP
	CS23700MP
	CS23700MP
	CS23700MP
	CS23700MP



CS14
Brétignac
Cevennes



181 x 69 x 230

	CS14067MP
	CS14700MP
	CS14700MP
	CS14700MP





CS24
Bréignac
Olympia

121 x 70 x 103

	CS24067MP
	CS24700MP
	CS24700MP
	CS24700MP



CS25

121 x 26 x 103

	CS25067MP
	CS25700MP
	CS25700MP
	CS25700MP

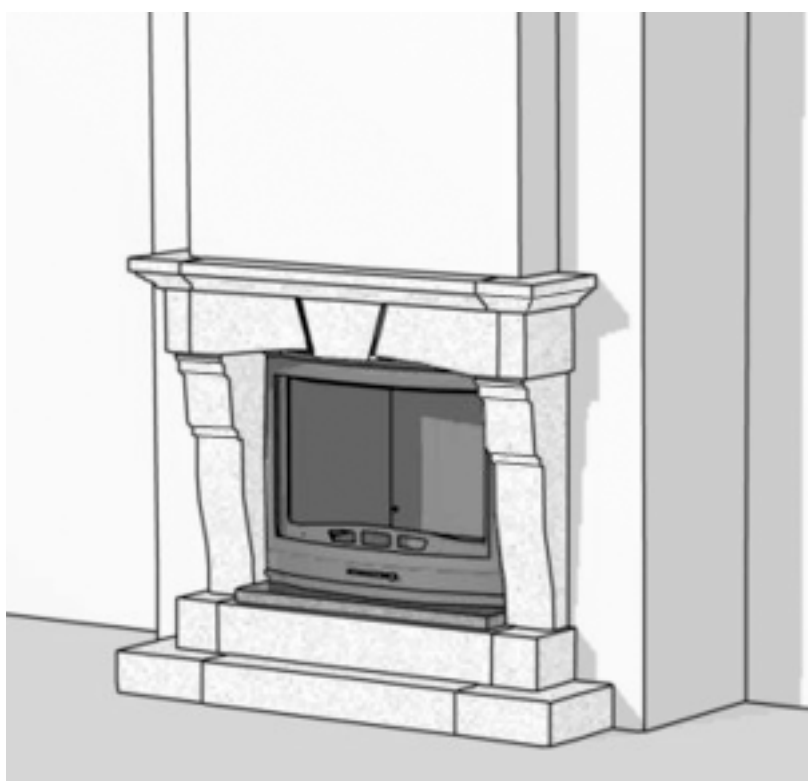



CS27
Mauzens



129 x 12 x 90

	CS27067MP
	CS27700MP
	CS27700MP



CS26
Brétignac



129 x 19 x 102

	CS26067MP
	CS26700MP
	CS26700MP





CS36
Mauzens
Bourgogne

95 x 67 x 115

	CS36700MP
	CS36700MP
	CS36700MP

95 x 62 x 115

	CS35700MP
	CS35700MP
	CS35700MP



CS35

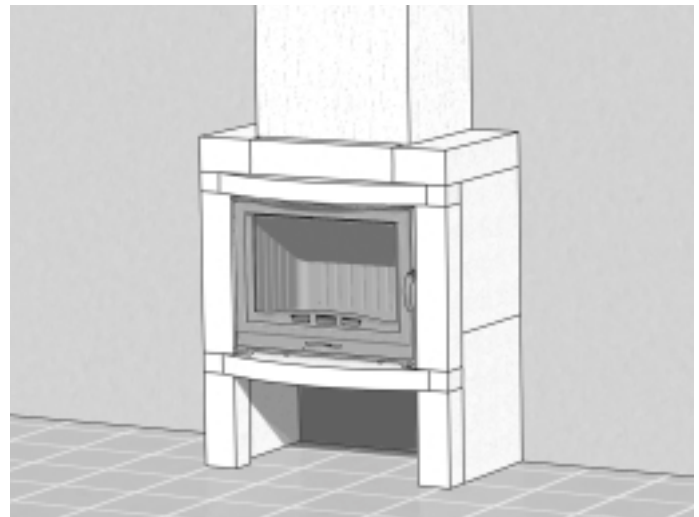

CS29
Brétignac
Color 01

100 x 4 x 85

	CS29067MM
	CS29D70MM

Color 01	Color 02
Color 03	Color 04



CS28
Mauzens

99 x 3 x 84

	CS28067MP
	CS28700MP
	CS28700MP



CS37

101 x 75 x 113

	CS37P70MP
--	-----------



CS38
Brétignac
Marquina

90/90 x 113

	CS38P70MP
--	-----------





CS30
Mauzens
Alicante



157 x 77 x 91

	CS30067MP
	CS30700MP
	CS30700MP
	CS30700MP
	CS30P70MP



CS31
Brétignac
Tiréno



130 x 75 x 90

	CS31067MP
	CS31700MP
	CS31700MP
	CS31700MP
	CS31P70MP

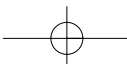



CS33
Brétignac
Olympia

167 x 70 x 89



	CS33067MP
	CS33700MP
	CS33700MP
	CS33700MP
	CS33700MP
	CS33700MP
	CS33700MP

167 x 70 x 89

	CS34067MP
	CS34700MP
	CS34700MP
	CS34700MP
	CS34700MP
	CS34700MP
	CS34700MP



CS34

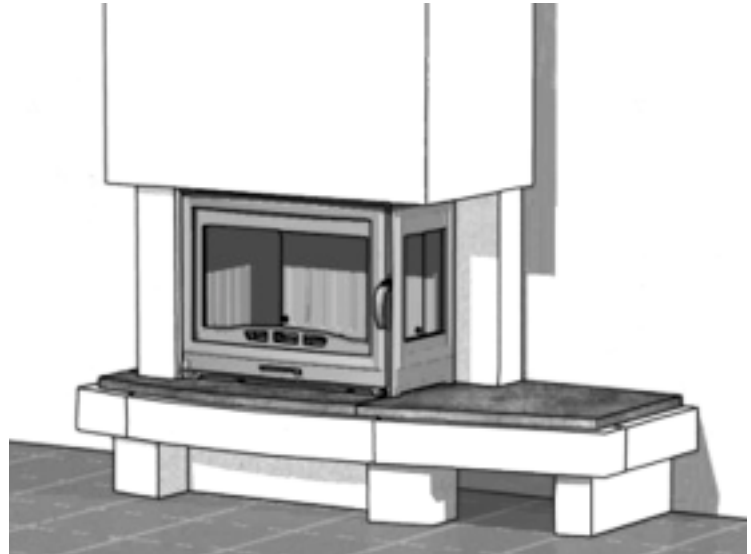

CS32
Brétignac
Marquina

131 x 75 x 89



	CS32067MP
	CS32700MP
	CS32700MP
	CS32700MP
	CS32700MP
	CS32700MP
	CS32P70MP

> G70



> P70



> D70



> D70D+G



> D70 D



> D70 G

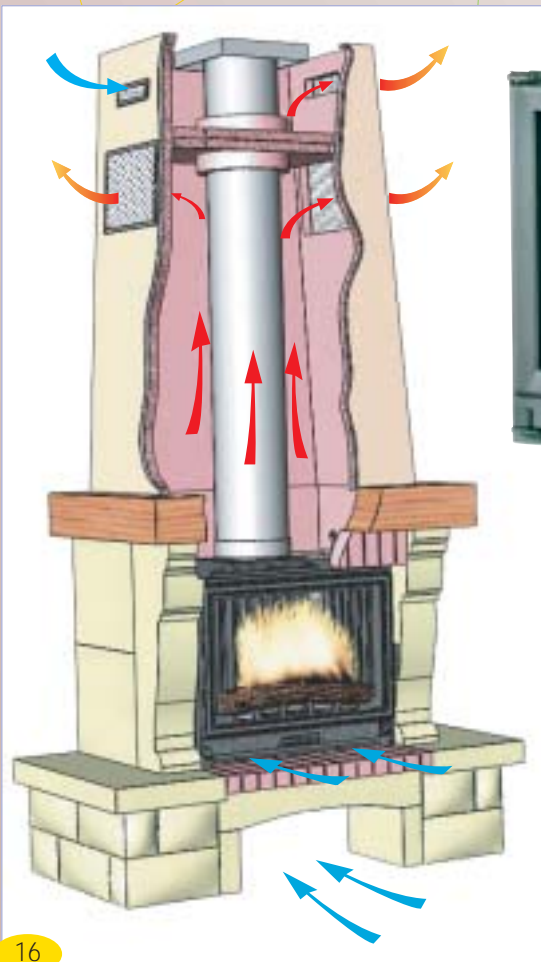



>V70

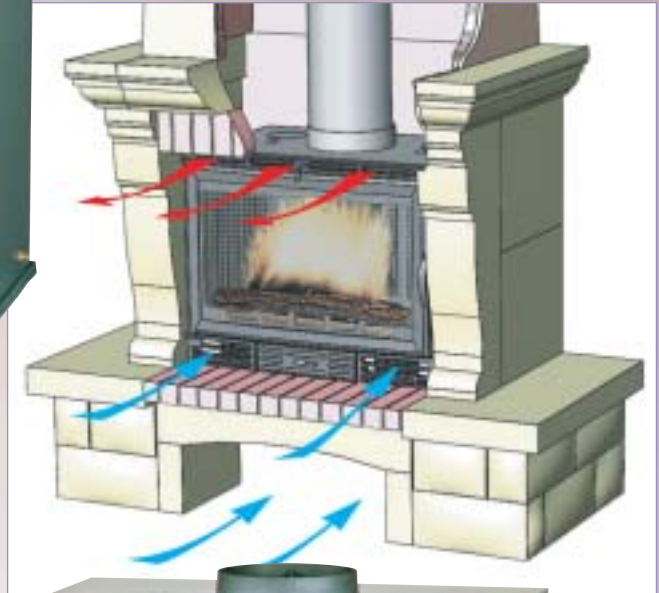

- Inserts
- Inserts
- Insert
- Kamineinsätze
- Focare
- Топки



>V80

Reference Number / Référence Referencia / Referenz Референс / код товара	G70	P70	D70	D70D U/DG	D70 U+G	V70	V80
Weight / Poids / Peso Gewicht / Greutate Вес	110	125	107	113	125	130	175
Nominal power (Kw) Puissance nominale (Kw) Potencia nominal (Kw) Nominale Leistung (Kw) Potere nominale (Kw) Номинальная мощность (кВт)	11,5	11,5	14	13	12,5	10	14,5
Diameter of connection (mm) Diámetro de conexión (mm) Diámetro de conexión (mm) Anschlussdurchmesser (mm) Diámetro de conexión (mm) Диаметр подсоединения (мм)	200	200	200	200	200	200	230
width / largeur ancho / Breite largime / ширина	698	698	698	713	727	694	794
Dimensions (mm) Dimensions (mm) Dimensiones (mm) Abmessungen (mm) Dimensiuni (mm) Размеры (мм)	483	530	437	437	437	406	552
Depth / profondeur profundidad / Tiefe adâncime / глубина	638	638	638	638	638	585	613
height / hauteur altura / Höhe înălțime / высота	550	550	550	550	550	550	580
Lintel height / hauteur linteau altura dintel / Höhe Sturz înălțime linteou / высота каминной полки	550	550	550	550	550	550	580
Classification according to NF EN 13229 CE Compliance Classification suivant NF EN 13229 Conformité CE Clasificación según NF EN 13229 Conformidad CE Klassifizierung gem. NF EN 13229 CE konform Clasificare după NF EN 13229 Conformitate CE Классификация по NF EN 13229 Соответствует требованиям CE	✓	✓	✓	✓	✓	✓	✓
Classification according to NF EN 50165 CE electrical compliance Classification suivant NF EN 50165 Conformité CE électrique Clasificación según NF EN 50165 Conformidad CE eléctrica Klassifizierung gem. NF EN 50165 Entspricht CE für Elektrik Clasificare după NF EN 50165 Conformitate electrică CE Классификация по NF EN 50165 Соответствует требованиям CE по электрооборудованию						✓	✓





**EARTHENWARE STOVES / POELAS FAIENÇA / ESTUFAS LOZA
KACHELOFEN / SOBE DE FAIANÇA / ПЕЧИ ФАЯНСОВЫЕ**



FREIBURG

Weight : 295 kg	Gewicht : 295 Kg
Dimensions : H1350 x W996 x D610 mm	Abmessungen : H1350 x B996 x T610 mm
Poids : 295 Kg	Greutate : 295 kg
Dimensions : H1350 x L996 x P610 mm	Dimensiuni : H1350 x L996 x A610 mm
Peso : 295 kg	Вес : 295 kg
Dimensiones : A1350 x A996 x P610 mm	Размеры : B1350 x D996 x Ш610 mm



Weight : 320 kg
Dimensions :
H1150 x W921 x D610 mm

Poids : 320 Kg
Dimensions :
H1150 x L921 x P610 mm

Peso : 320 kg
Dimensiones :
A1150 x A921 x P610 mm

Gewicht : 320 Kg
Abmessungen :
H1150 x B921 x T610 mm

Greutate : 320 kg
Dimensiuni :
H1150 x L921 x A610 mm

Вес : 320 kg
Размеры :
B1150 x D921 x Ш610 mm

COBLENCE



Chazelles



Power : 11 Kw
Dimensions :
H795 x L780 x D550 mm
Weight : 160 kg
Connection diameter:
150 mm from above or from behind.

Puissance : 11 Kw
Dimensions :
H795 x L780 x P550 mm
Poids : 160 kg
Diamètre raccordement :
150 mm par dessus ou par derrière

Potencia : 11 Kw
Dimensiones :
A795 x A780 x P550 mm
peso : 160 kg
Diámetro de conexión :
150 mm por encima o por detrás

Leistung : 11 Kw
Abmessungen :
H795 x B780 x T550 mm
Gewicht : 160 kg
Anschlussdurchmesser :
150 mm darüber oder dahinter

Putere : 11 Kw
Dimensiuni :
1795 x L780 x A550 mm
Greutate : 160 kg
Diametru de conectare :
150 mm pe sus sau prin spate

Номинальная мощность : 11 Kw
Размеры :
B795 x D780 x Ш550 mm
Вес : 160 kg
Диаметр подсоединения :
150 мм сверху или сзади

RUSTIC STOVES / POELES "RUSTIQUES" / ESTUFAS RÚSTICAS RUSTIKALER OFEN / SOBE RUSTICE / ПЕЧИ РУСТИК

NIGHT BLUE
ENAMEL FINISHING

BLEU NUIT
FINITION EMAILÉE

AZUL OSCURO
ACABADO ESMALTADO

NACHTBLAU
GLASIERTE ENDVERARBEITUNG

ALBASTRUO NOCTURN
FINISAJ EMAILAT

Глубокий синий
Отделка эмалью



IRON GREY

GRIS FONTE

GRIS FUNDICIÓN

GUSSEISEN GRAU

GRI FONTĂ

Цвет серого чугуна



GREEN
ENAMEL FINISHING

VERT
FINITION EMAILÉE

VERDE
ACABADO ESMALTADO

GRÜN
GLASIERTE ENDVERARBEITUNG

VERDE
FINISAJ EMAILAT

зеленый
Отделка эмалью



IVORY
ENAMEL FINISHING

IVOIRE
FINITION EMAILÉE

MARFIL
ACABADO ESMALTADO

ELFENBEIN
GLASIERTE ENDVERARBEITUNG

FILDEŞ
FINISAJ EMAILAT

Цвет слоновой кости
Отделка эмалью





MODERN STOVES / POELES "MODERN" / ESTUFAS MODERN OFEN MODERN / SOBE MODERN / ПЕЧИ МОДЕРН



GREY
ENAMEL FINISHING

GRIS
FINITION ÉMAILLÉE

GRIS
ACABADO ESMALTADO

GRAU
GLASIERTE ENDVERARBEITUNG

GRI
EMAILAT

Серый
Отделка эмалью



Power : 10,6 Kw
Dimensions :
H829 x L762 x D566 mm
Weight : 210 kg
Connection diameter:
150 mm from above or from behind.

Puissance : 10,6 Kw
Dimensions :
H829 x L762 x P566 mm
Poids : 210 kg
Diamètre raccordement :
150 mm par dessus ou par derrière.

Potencia : 10,6 Kw
Dimensiones :
A829 x A762 x P566 mm
peso : 210 kg
Diámetro de conexión :
150 mm por encima o por detrás

Leistung : 10,6 Kw
Abmessungen :
H829 x B762 x T566 mm
Gewicht : 210 kg
Anschlussdurchmesser :
150 mm darüber oder dahinter

Putere : 10,6 Kw
Dimensiuni :
i829 x L762 x A566 mm
Greutate : 210 kg
Diametru de conectare :
150 mm pe sus sau prin spate

Номинальная мощность : 10,6 Kw
Размеры :
В829 x Д762 x Ш566 мм
Вес : 210 kg
Диаметр подсоединения :
150 мм сверху или сзади



BEIGE
ENAMEL FINISHING

BEIGE
FINITION ÉMAILLÉE

BEIGE
ACABADO ESMALTADO

BEIGE
GLASIERTE ENDVERARBEITUNG

BEJ
EMAILAT

Бежевый
Отделка эмалью



IRON GREY

GRIS FONTE

GRIS FUNDICIÓN

GUSSEISEN GRAU

FONTA GRI

Цвет серого чугуна



Usine : Route de Marthon - 16380 CHAZELLES
Tél. 33(0)5 45 23 50 50 - Fax : 33(0)5 45 23 53 09
www.chazelles.com
Chinvest SA au capital de 320 000 € - R.C.S. Angoulême
B 408 337 970 - Siret 408 337 970 000 11